

TYPE RREP

HIGH DUTY CARTRIDGE O-RING SEAL

Technical Specification

- A – Face/Primary Ring
- B – Seat/Mating Ring
- C – Anti-Extrusion Rings
- D – Spring
- E – Sleeve
- F – Seal Ring Carrier

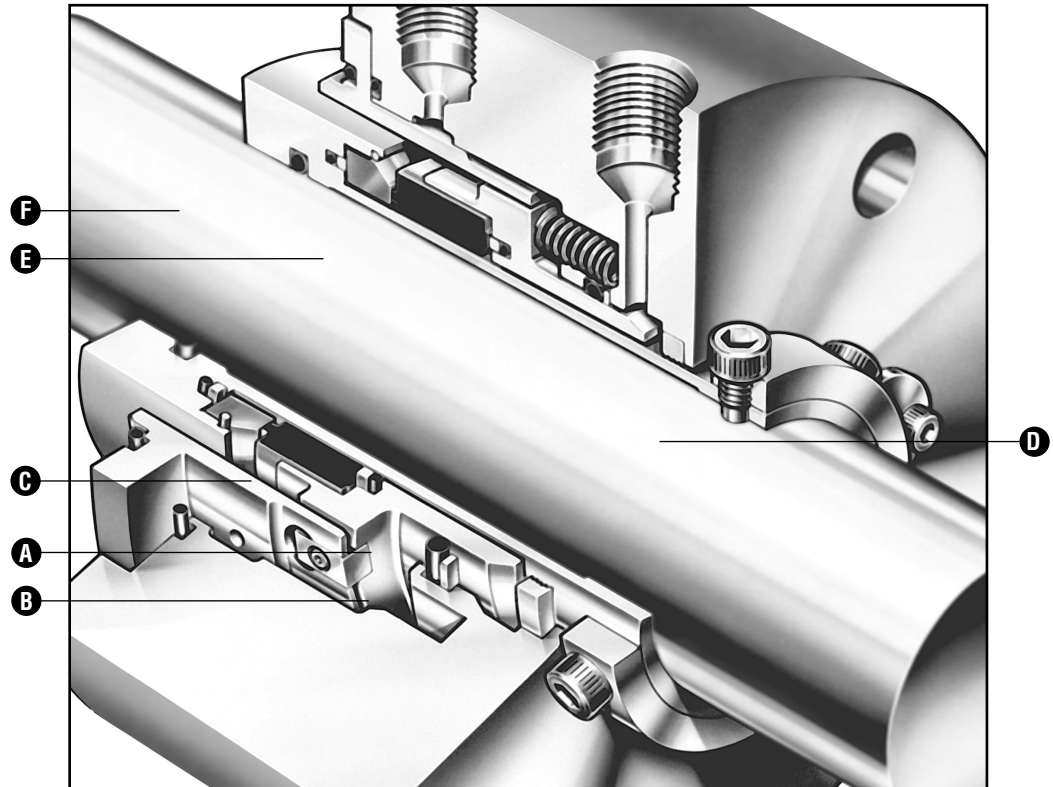

Product Description

The Type RREP Cartridge O-ring Seal, available in single and dual arrangements, is designed for high pressure and high speed applications.

- The RREP can be used for hydrocarbons, sour gas, crude oil, boiler feed water, propane, ethane and butane services
- It is ideally suited for use offshore and onshore, in pipeline and injection service, and in power generation plants
- The stationary multi-spring design maintains a stable, fluid film even at extremes of speed and pressure
- Complies with API 610 and can be supplied to meet other international standards such as NACE MR-01-075
- The axially compact design allows for use on pumps with close bearing centers

Design Features

- Multi-point injection, optional through-spring flush for dirty parts
- Available in double, tandem and dry tandem arrangements
- Fea optimized seal rings
- Hard coating under the sliding O-ring
- Monel® anti-rotation keys or pins
- Ptfе/composit anti-extrusion rings

Performance Capabilities

- Temperature: -40°F to 600°F/-40°C to 315°C
- Pressure: vacuum to 2540 psi(g)/175 bar(g)
- Speed: up to 11,000 fpm/55 m/s

TYPE RREP

HIGH DUTY CARTRIDGE O-RING SEAL

Type RREP Typical Arrangement/Dimensional Data

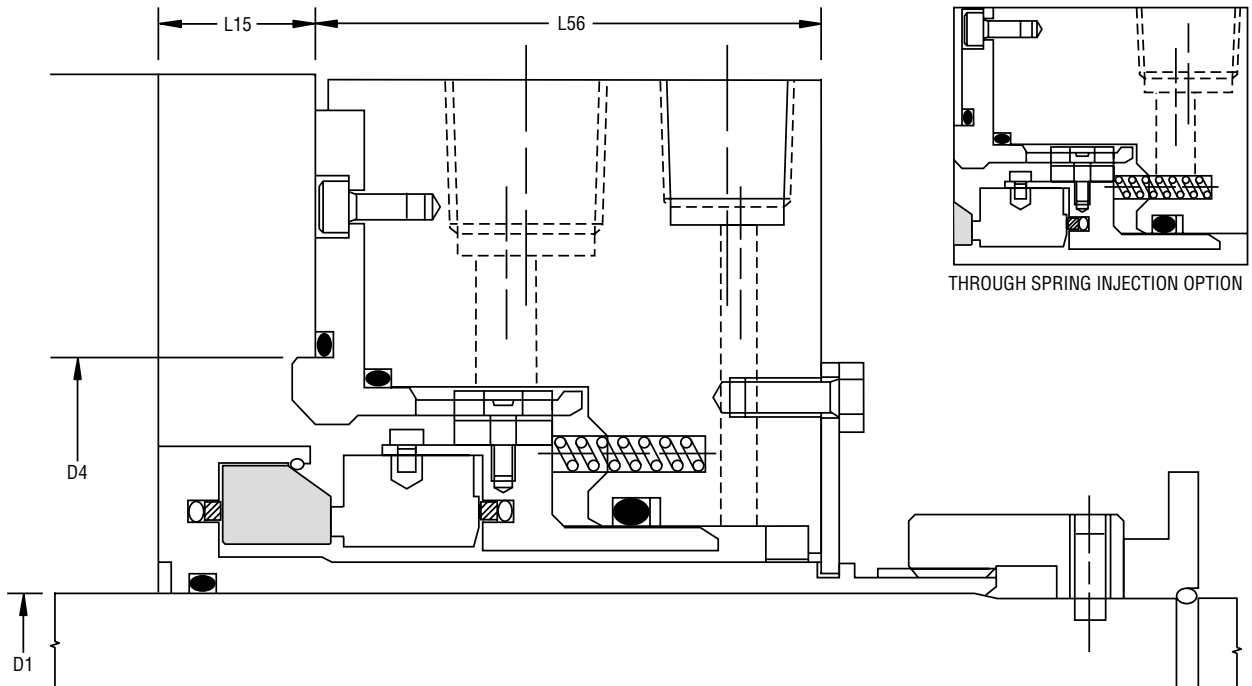

Type RREP Dimensional Data (mm)

Seal Size Code (mm)	Max. Shaft Diameter D1	Box Bore D4	Multi-Point Injection		Through-Spring Circulation	
			L15	56	L15	L56
0400	35.0	71.00	0	92.0	15	77.0
0450	40.0	75.50	0	92.0	15	77.0
0500	45.0	83.50	0	95.5	15	80.5
0560	51.0	88.50	0	95.5	15	80.5
0600	56.0	95.50	0	95.5	15	80.5
0630	59.0	97.50	8	97.5	23	82.5
0670	63.0	102.00	8	97.5	23	82.5
0700	66.5	107.00	8	97.5	23	82.5
0750	70.0	111.50	11	97.5	26	82.5
0800	76.0	116.50	11	97.5	26	82.5
0850	79.5	123.00	10	98.5	26	82.5
0900	83.5	127.50	10	98.5	26	82.5
0950	89.0	133.50	10	98.5	26	82.5
1000	94.0	140.50	10	98.5	26	82.5
1050	100.5	144.50	10	98.5	26	82.5
1100	104.0	152.50	10	98.5	26	82.5
1150	110.0	159.00	10	98.5	26	82.5
1200	113.5	162.50	10	98.5	26	82.5
1250	120.0	173.00	10	98.5	26	85.5
1300	123.0	176.00	15	106.5	36	85.5
1350	128.0	180.50	15	106.5	36	85.5
1400	133.0	186.00	15	106.5	36	85.5
1450	138.0	193.00	15	106.5	36	85.5
1500	146.5	206.50	15	106.5	36	85.5
1600	157.0	216.50	15	106.5	36	85.5
1700	166.5	226.50	15	106.5	36	85.5
1800	176.0	240.50	15	106.5	36	85.5
1900	185.0	247.50	15	111.5	31	85.5
2000	196.0	261.35	10	111.5	31	90.5

Type RREP Dimensional Data (inches)

Seal Size Code (mm)	Max. Shaft Diameter D1	Box Bore D4	Multi-Point Injection		Through-Spring Circulation	
			L15	L56	L15	L56
0400	1.38	2.79	0.00	3.62	0.59	3.03
0450	1.57	2.97	0.00	3.62	0.59	3.03
0500	1.77	3.28	0.00	3.75	0.59	3.16
0560	2.01	3.48	0.00	3.75	0.59	3.16
0600	2.20	3.76	0.00	3.75	0.59	3.16
0630	2.32	3.84	0.31	3.83	0.91	3.24
0670	2.48	4.00	0.31	3.83	0.91	3.24
0700	2.62	4.21	0.31	3.83	0.91	3.24
0750	2.76	4.39	0.43	3.83	1.02	3.24
0800	2.99	4.59	0.43	3.83	1.02	3.24
0850	3.13	4.84	0.39	3.88	1.02	3.24
0900	3.29	5.02	0.39	3.88	1.02	3.24
0950	3.50	5.25	0.39	3.88	1.02	3.24
1000	3.70	5.53	0.39	3.88	1.02	3.24
1050	3.96	5.69	0.39	3.88	1.02	3.24
1100	4.09	6.00	0.39	3.88	1.02	3.24
1150	4.33	6.25	0.39	3.88	1.02	3.24
1200	4.47	6.39	0.39	3.88	1.02	3.24
1250	4.72	6.81	0.39	3.88	1.02	3.37
1300	4.84	6.93	0.59	4.19	1.41	3.37
1350	5.04	7.11	0.59	4.19	1.41	3.37
1400	5.24	7.32	0.59	4.19	1.41	3.37
1450	5.43	7.60	0.59	4.19	1.41	3.37
1500	5.77	8.12	0.59	4.19	1.41	3.37
1600	6.18	8.52	0.59	4.19	1.41	3.37
1700	6.56	8.92	0.59	4.19	1.41	3.37
1800	6.93	9.46	0.59	4.19	1.41	3.37
1900	7.28	9.74	0.59	4.38	1.22	3.37
2000	7.72	10.29	0.39	4.38	1.22	3.56

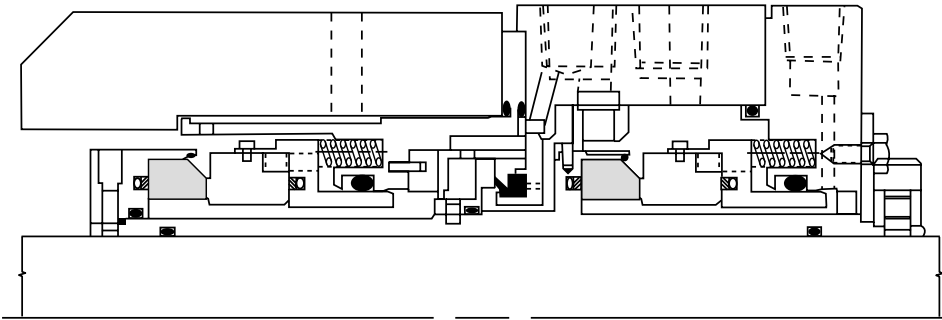
Type RRTP Typical Arrangement

The dual, unpressurized (tandem) arrangement consists of two seals in series. The inner seal operates on pumped fluid and the outer seal normally operates on a low pressure buffer liquid. The outer seal is designed to provide a full-duty backup service.

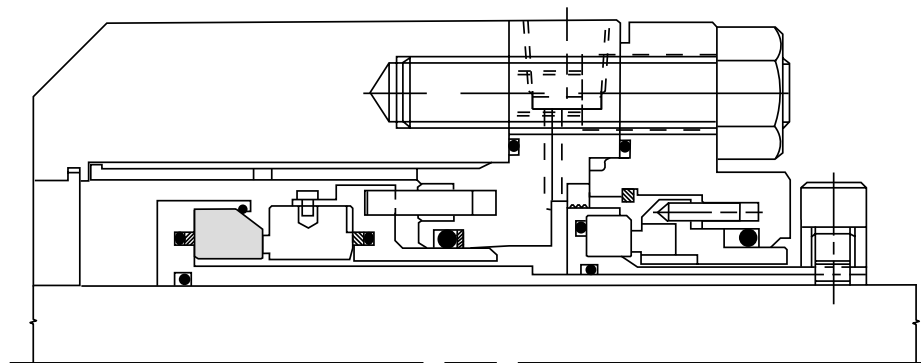
Type RRCP Typical Arrangement

The dry tandem arrangement uses the high duty version of the SBOP backup seal to provide operational security without the expense of a liquid buffer system. In the event of failure of the inner seal, the SBOP will prevent loss of the pumped fluid to the atmosphere. This can be detected by use of a pressure switch.

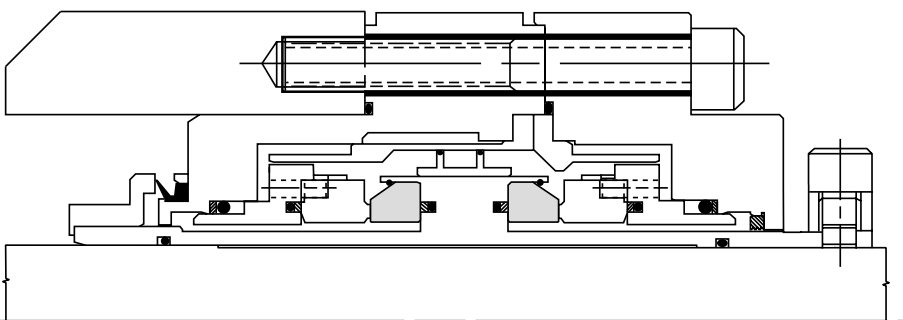
Type RRDP Typical Arrangement

This dual pressurized (double) arrangement consists of two seals face to face and operating on a barrier liquid. Any leakage from the inner seal will be of barrier fluid into the pumped product. The inner seal includes a double balance line for reverse pressure protection.

Note: The above seals are normally designed to suit a particular machine or application. For approximate installation dimensions, consult John Crane.

Multiplier Factors

	Selection Considerations	Multiplier Factor
Sealed Fluid Lubricity	Petrol/Gasoline, Kerosene, or Better Flashing Hydrocarbons* (Specific Gravity ≤ 0.65)	x 1.00
		x 0.60
Sealed Fluid Temperature** (for carbon only)	Up to 175°F/80°C From 175°F to 250°F/80°C to 120°C From 250°F to 355°F/120°C to 180°C Above 355°F/180°C	x 1.00
		x 0.90
		x 0.80
		x 0.65
Speed	Up to 3600 rpm Above 3600 rpm***	x 1.00
		x 3600/ new speed

*The ratio of sealed pressure to vapor pressure must be greater than 1.5, otherwise consult John Crane. If the specific gravity is less than 0.60, consult John Crane.

**For temperatures over 355°F/180°C refer application to John Crane.

***Up to maximum speed of 11,000 fpm/55 m/s.

Example for Determining Pressure Rating Limits:

Seal: 3"/76.2Mm diameter Type RREP

Product: crude oil

Face materials: silicon carbide vs. tungsten carbide

Operating temperature: 194°F/90°C

Pressure: 1160 psi(g)/80 bar(g)

Speed: 4500 rev./min.

Using the pressure rating limits graph, the maximum pressure would be 2540 psi(g)/175 bar(g).

From the multiplier factors chart, apply the multipliers for the specific service requirements to determine the maximum operating pressure for the application.

$$2540 \text{ psi}/175 \text{ bar} \times 1.00 \times 3600/4500 =$$

$$2030 \text{ psi}/140 \text{ bar}$$

The maximum operating pressure for this 3"/76.2mm Type RREP is 2030 psi/140 bar.

Basic Pressure Rating (Hydrocarbons)

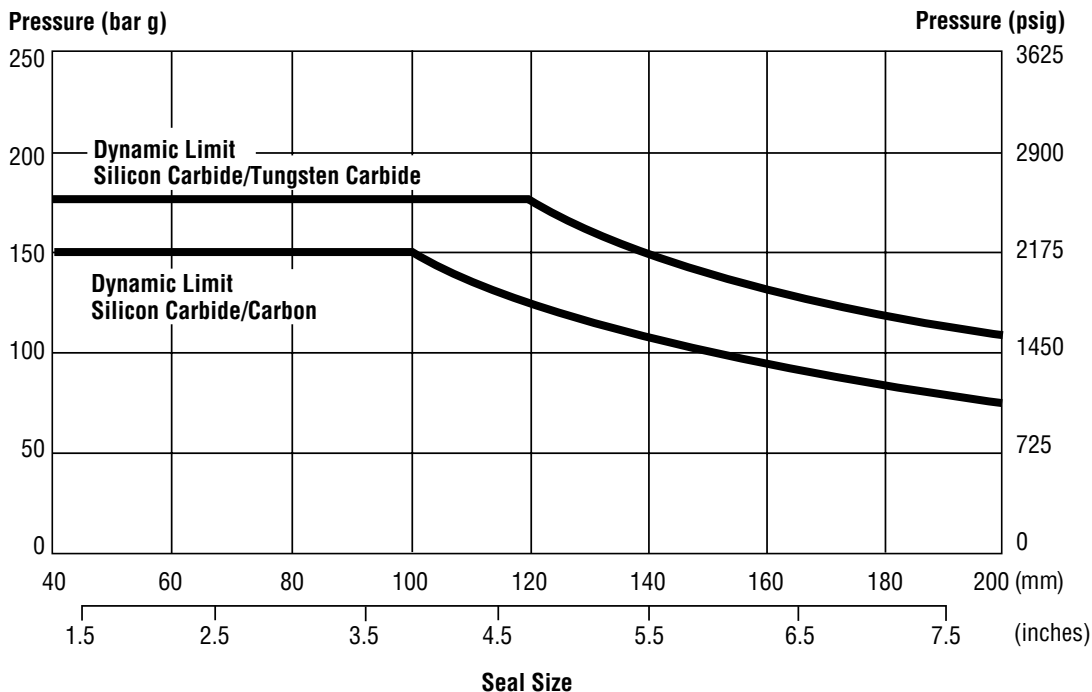

The basic pressure rating is for a standard seal, as shown in the typical arrangement, when installed according to the criteria given in this data sheet and generally accepted industrial practices.

The basic pressure rating assumes stable operation at 3600 rpm in a clean, cool, lubricating, non-volatile liquid with an adequate flush rate. When used with the multiplier factors, the basic pressure rating can be adjusted to provide a conservative estimate of the dynamic pressure rating. For process services outside this range or a more accurate assessment of the dynamic pressure rating, contact John Crane for more information.

Multiplier Factors (Aqueous Solutions)

	Selection Considerations	Multiplier Factor
Sealed Fluid Temperature** (for carbon only)	Up to 175°F/80°C	x 1.00
	From 175°F to 250°F/80°C to 120°C	x 0.90
	From 250°F to 355°F/120°C to 180°C	x 0.80
	Above 355°F/180°C	x 0.65
Speed	Up to 3600 rpm	x 1.00
	Above 3600 rpm***	x 3600/ new speed

*For temperatures over 355°F/180°C refer application to John Crane.

** Up to maximum speed of 11,000 fpm/55 m/s.

Basic Pressure Rating (Water and Aqueous Solutions)

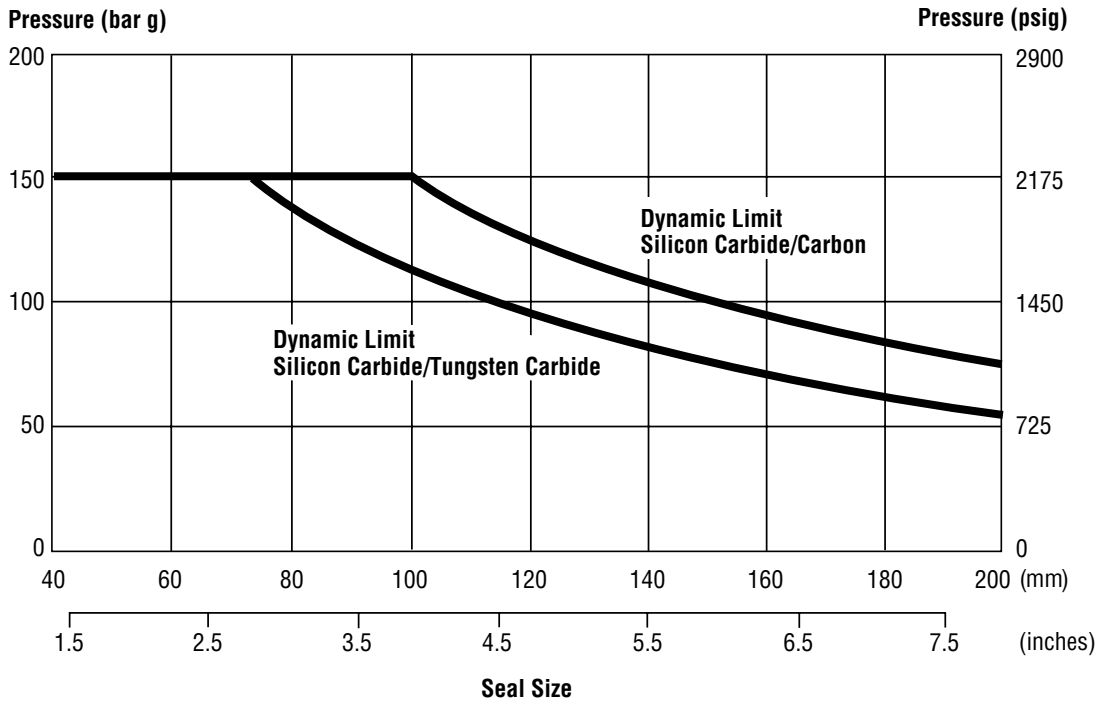

The basic pressure rating is for a standard seal, as shown in the typical arrangement, when installed according to the criteria given in this data sheet and generally accepted industrial practices.

The basic pressure rating assumes stable operation at 3600 rpm in a clean, cool, lubricating, non-volatile liquid with an adequate flush rate. When used with the multiplier factors, the basic pressure rating can be adjusted to provide a conservative estimate of the dynamic pressure rating. For process services outside this range or a more accurate assessment of the dynamic pressure rating, contact John Crane for more information.

Materials of Construction

Seal Components	Materials	
	Standard	Options
Face/Primary Ring	Carbon Graphite	Nickel Bound Tungsten Carbide Silicon/Graphite Composite
Seat/Mating Ring	Silicon Carbide	—
Secondary O-rings	Ethylene Propylene Fluorocarbon Nitrile Perfluoroelastomer	PTFE/Spring Energized PTFE* High Temperature Polymer*
Anti-Extrusion Ring	PTFE/Composit	—
Springs	Inconel®	Alloy C-276
Metal Components	316 Stainless Steel	Duplex Stainless Steel (UNS S31803) Materials to NACE MR-01-75

*Refer to John Crane

Hydrostatic/Static Pressure Limits

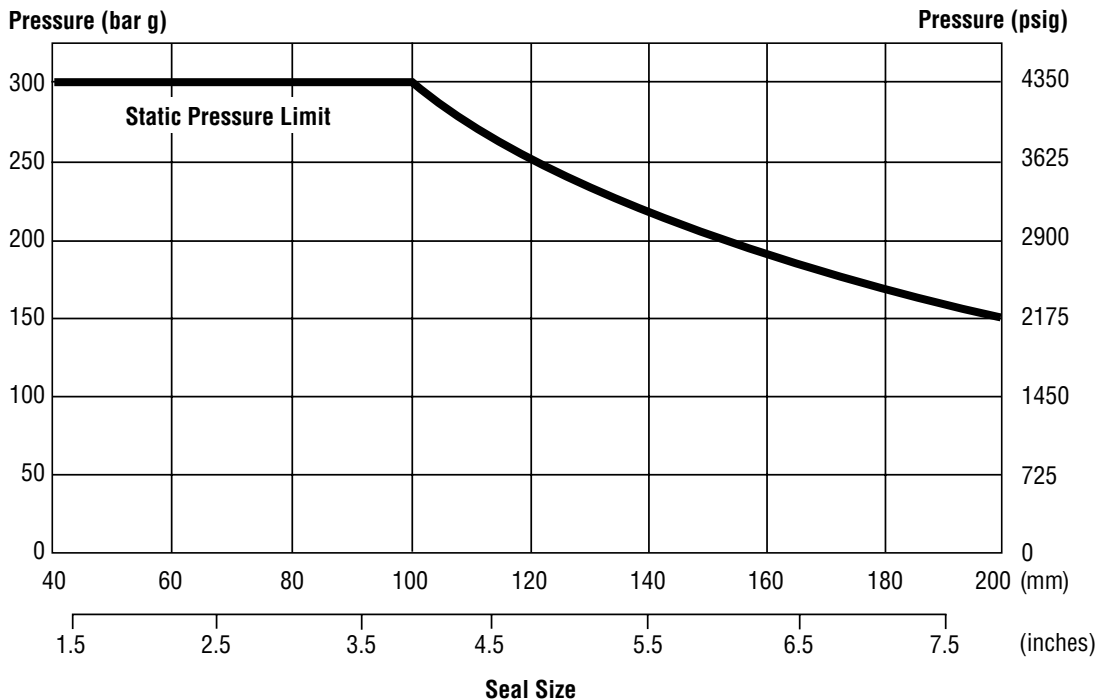

john crane

TYPE RREP

HIGH DUTY CARTRIDGE O-RING SEAL

Technical Specification

Monel is a registered trademark of Inco Alloys International, Inc.

Inconel is a registered trademark of Inco Alloys International, Inc.



North America
United States of America

Tel: 1-847-967-2400
Fax: 1-847-967-3915

Europe
United Kingdom

Tel: 44-1753-224000
Fax: 44-1753-224224

Latin America
Brazil

Tel: 55-11-3371-2500
Fax: 55-11-3371-2599

Middle East & Africa
United Arab Emirates

Tel: 971-481-27800
Fax: 971-488-62830

Asia Pacific
Singapore

Tel: 65-6518-1800
Fax: 65-6518-1803

If the products featured will be used in a potentially dangerous and/or hazardous process, your John Crane representative should be consulted prior to their selection and use. In the interest of continuous development, John Crane Companies reserve the right to alter designs and specifications without prior notice. It is dangerous to smoke while handling products made from PTFE. Old and new PTFE products must not be incinerated. ISO 9001 and ISO 14001 Certified, details available on request.