

- A - Bellows Assembly
- B - Insert/Primary Ring
- C - Mating Ring/Seat
- D - O-Ring
- E - Sleeve
- F - Gland
- G - Gland O-Ring
- H - Segmented Bushing Assembly
- I - Distributed Flush

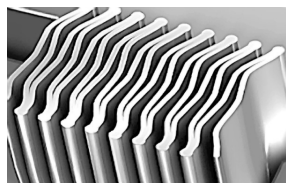
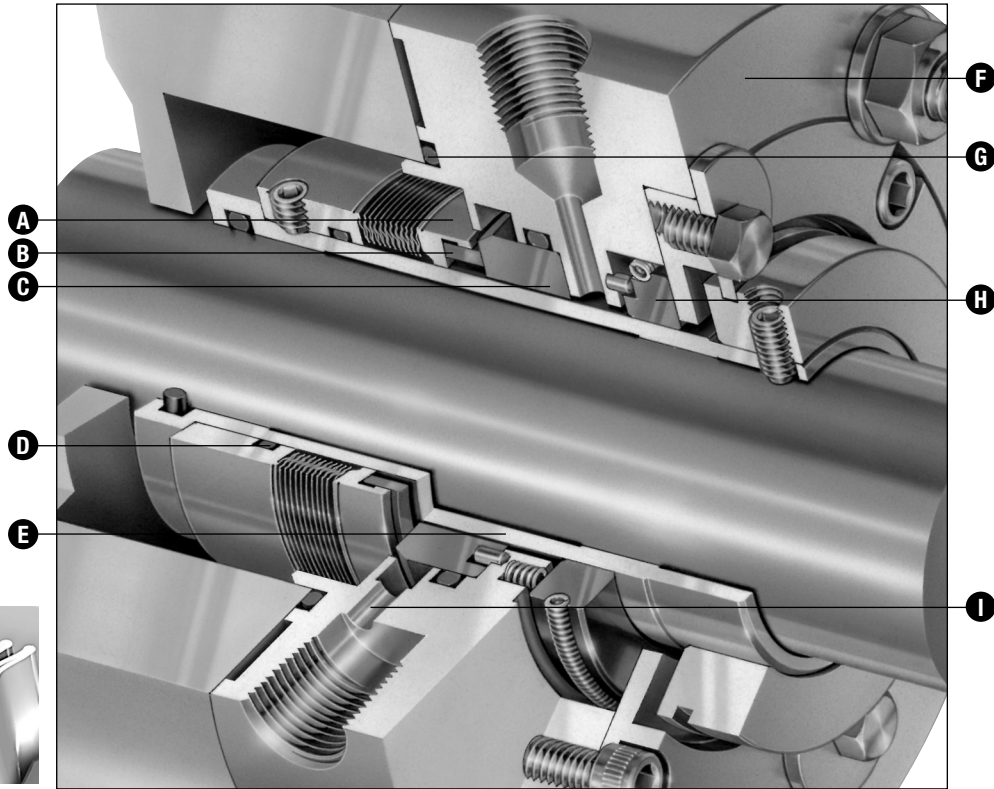

Welded Metal Bellows

Type 1670

(Category 2 or 3 with segmented bushing and distributed flush shown)

### Product Description

Type 1670- Category 2 and 3, Type B, Arrangement 1 single rotating alloy C-276 (UNS N10276) bellows cartridge seal is available with a fixed, floating, or segmented bushing option with either a single point or distributed flush arrangement. Category 3 seals are provided the appropriate documentation in accordance with API 682.

### Performance Capabilities

- Temperature: -100°F to 500°F / -75°C to 260°C (depending on material used)
- Pressure: vacuum to 300 psi(g)/20 bar(g)
- Speed: up to 5000 fpm/25 m/s
- Shaft size: 0.750" to 3.750"/19mm to 95.25mm

### Design Features

- API 682 qualification tested
- Edge-welded metal bellows
- Easy-to-install cartridge design with registered fit
- Static secondary seals
- Standard components
- Segmented spring-loaded carbon throttle bushing for effective containment (optional)
- Distributed flush optimizes circulation of liquid at faces and prevents trapped vapor
- Available with a pumping ring when utilizing an API Plan 23

### Typical Applications

- Hydrocarbons
- Aromatic fractionation products (benzene, toluene, solvents, etc.)
- Crude oil fractionation products (fuel oil, lubricating oil, gasoline, etc.)
- Chemicals
- Caustics
- Some acids
- Aqueous solutions
- Lubricating liquids

### Type 1670 API Type B Arrangement 1 - Single Cartridge

Type 1670 Standard Arrangement Shown (Category 2 Seal)

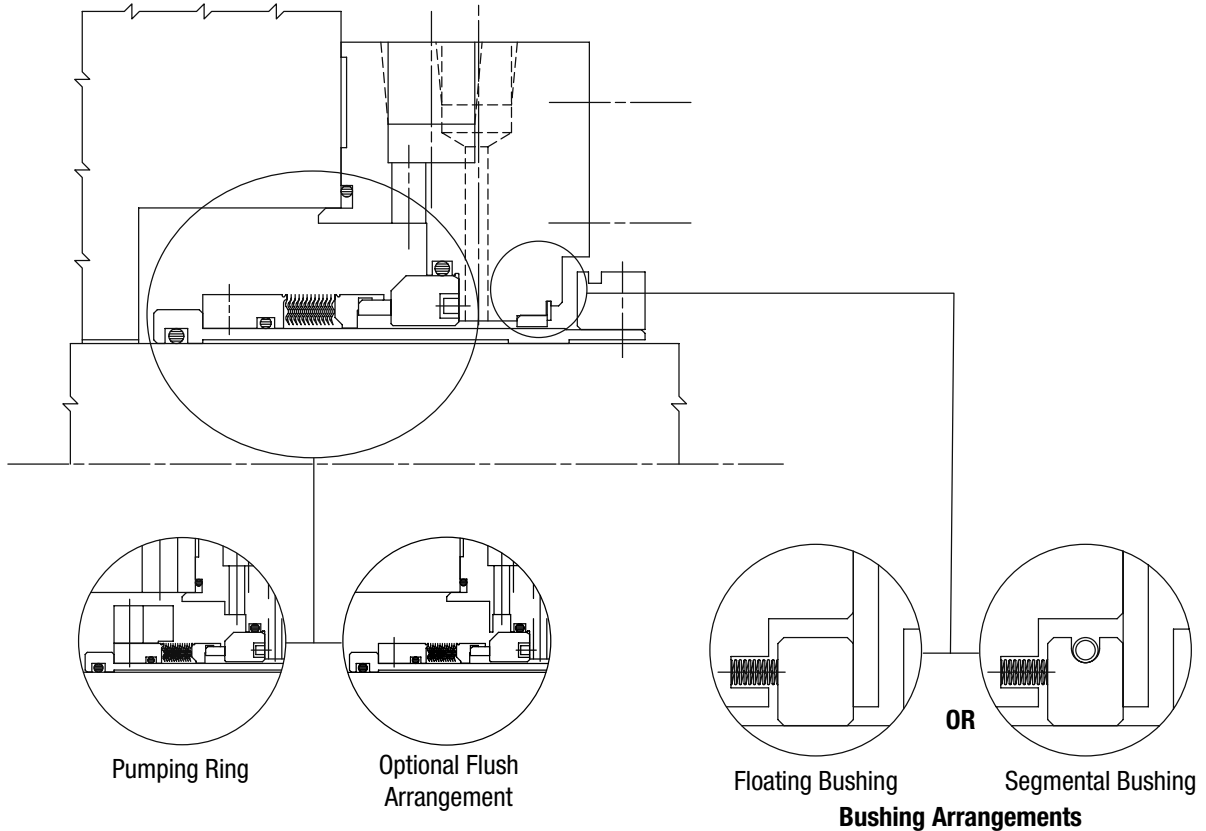

### Basic Pressure Rating

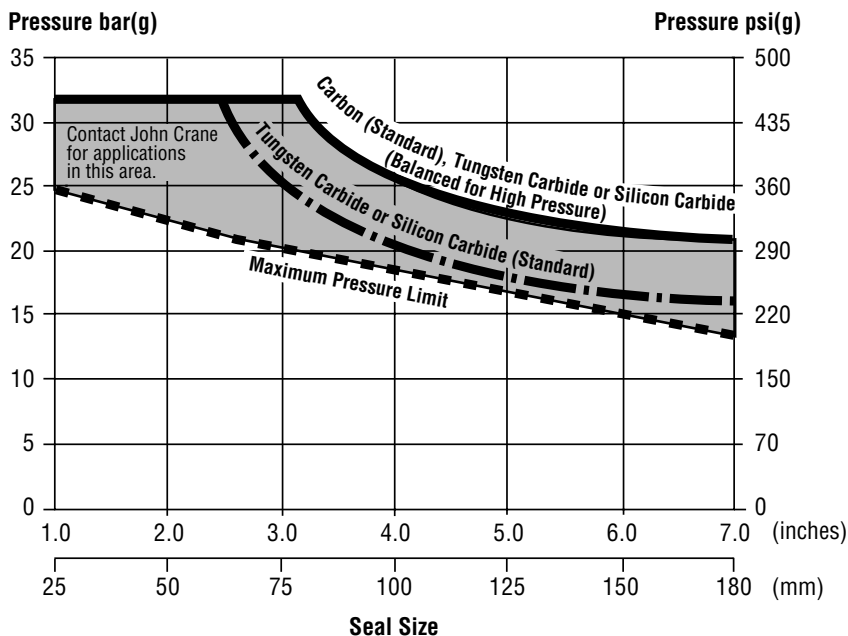

The basic pressure rating is for a standard seal as shown in the typical arrangement, when installed according to the criteria given in this data sheet and generally accepted industrial practices.

The basic pressure rating assumes stable operation at 3600rpm in a clean, cool, lubricating, non-volatile liquid with an adequate flush rate. When used with the multiplier factors, the basic pressure rating can be adjusted to provide a conservative estimate of the dynamic pressure rating.

For process services outside this range or for a more specific assessment of the dynamic pressure rating, contact John Crane.

**Notes:**

1. Basic pressure rating curve based on single-ply bellows.
2. Basic pressure rating curve is differential pressure applied to seal outside diameter.
3. Consult John Crane for applications outside these limits.

### Multiplier Factors

	Selection Considerations	Multiplier Factors	
		Carbon vs. SiC	T/C vs. SiC
<b>Speed</b>	Up to 3600rpm Above 3600rpm	x 1.00 x (3600/ speed)	x 1.00 x (3600/ speed)
<b>Sealed Fluid Lubricity</b>	Petrol/Gasoline, Kerosene, or Better Water and Aqueous Solutions (< 176°F/80°C) Flashing Hydrocarbons* (see note 1)	x 1.00 x 0.75 x 0.60	x 1.00 x 0.75 (see note 2)
<b>Sealed Fluid Temperature</b> (See note 3)	Up to 175°F /80°C Up to 250°F/120°C Up to 400°F/205°C	x 1.00 x 0.90 x 0.80	x 1.00 x 1.00 x 1.00

\* The ratio of sealed pressure to vapor pressure must be greater than 1.5, otherwise consult John Crane. If the specific gravity is less than 0.6, consult John Crane.

Notes:

1. Specific gravity ≥ 0.6 and ratio of sealed pressure to vapor pressure > 1.5
2. More details regarding the fluid and the operating conditions are required
3. Temperature at the seal faces includes effects of flush, quench and cooling

### Example for Determining Pressure Rating Limits:

Seal: Type 1670  
 Size: 2"/50mm  
 Product: 50/50 Glycol and Water  
 Face material: Carbon vs. Silicon Carbide  
 Operating temperature: 200°F/95°C  
 Operating speed: 3600rpm

### Example for determining dynamic Pressure rating:

The maximum pressure for a particular application is the lesser of the maximum pressure limit curve or the pressure calculated when the multiplier factors are applied to the specific seal face material curve.

Maximum pressure limit curve:

300 psi(g)/21 bar(g) max pressure

Carbon limit curve: 460 psi(g)/32 bar(g)

Calculated limit: 460 psi(g)/32 bar(g) x 1.00 x 0.75 x 0.90 = 310 psi(g)/20 bar(g)

At 3600rpm with the service conditions noted, a 2"/50mm (seal size) Type 1670 has a maximum operating pressure limit of 310 psi(g)/20 bar(g).

### Materials of Construction

SEAL COMPONENTS	MATERIALS	
Description	Standard	Options
Seat/Mating Ring	Silicon Carbide Reaction Bonded	—
Insert/Primary Ring	Premium Grade Carbon	Tungsten Carbide Nickel Bound Sintered Silicon Carbide
End Fittings	Alloy C-276 (UNS N10276)	—
Bellows	Alloy C-276 (UNS N10276)	—
Adaptive Hardware	316 Stainless Steel (UNS 31600)	—
Static Seals	Fluoroelastomer	Perfluoroelastomer Nitrile Ethylene Propylene TFE Encapsulated Fluorocarbon

### Seal Welded Metal Bellows

#### Design Features

- \* Optimum 45° tilt angle
- \* Three-sweep radius
- \* Nesting ripple plate design
- \* Static secondary seal
- \* Light spring loads

#### Benefits

- \* Uniform plate rigidity and stress distribution
- \* Enhanced fatigue strength
- \* Pressure-balanced by design
- \* Less heat
- \* Lower power consumption

### Angular and Radial Movement

Excessive runout will have a detrimental effect on seal performance in the form of component wear or excessive leakage. API 682 limits runout as follows:

- Centering of the seal is to be by a register fit. The register fit surface shall be concentric to the shaft and have a total indicated runout (FIM) of not more than 0.005"/125 micrometers.
- Squareness of the seal chamber face to the shaft shall not exceed 0.0005" per inch of seal chamber bore (15 micrometers per cm).
- Runout of the sleeve outer diameter to the inner diameter shall be 0.001"/25 micrometers FIM.
- Shaft-to-sleeve diametrical clearance shall be to Tolerance Grade F7/h6.

### Recommendations for Viscous Fluids

- 0 - 1,000 cSt: Standard seal
- 1,000 - 3,500 cSt: Hard face material
- 3,500 - 10,500 cSt: Consult John Crane Engineering

Note: SSU (Saybolt Universal Seconds) approximately equals cSt (centistoke) x 4.6347  
 cP (centipoise) = cSt (centistoke) x specific gravity.

### Piping Plans Recommended with the Type 1670

#### API Plan 11

Recirculation from pump case through orifice to seal.

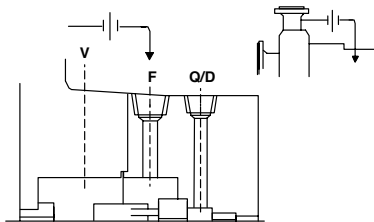

#### API Plan 62

External fluid quench (steam, gas, water, etc.) typically used with throttle bushing.

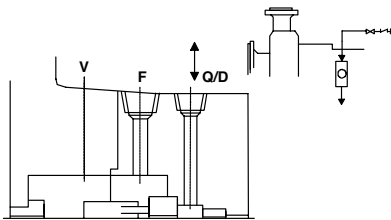

#### API Plan 32

Injection to seal from external source of clean cool fluid.

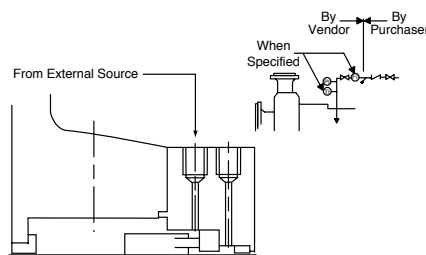

#### API Plan 23

Recirculation from seal with pumping ring through heat exchanger and back to seal.

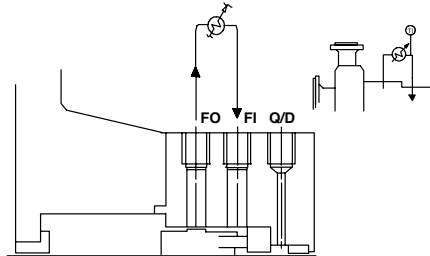

#### API Plan 21

Recirculation from pump case through orifice and cooler or heat exchanger to seal.

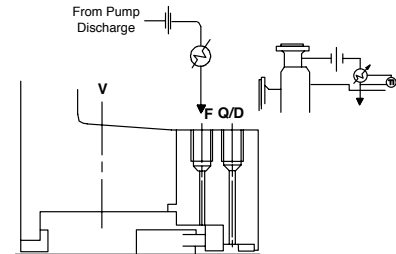

**North America**  
 United States of America  
 Tel: 1-847-967-2400  
 Fax: 1-847-967-3915

**Europe**  
 United Kingdom  
 Tel: 44-1753-224000  
 Fax: 44-1753-224224

**Latin America**  
 Brazil  
 Tel: 55-11-3371-2500  
 Fax: 55-11-3371-2599

**Middle East & Africa**  
 United Arab Emirates  
 Tel: 971-481-27800  
 Fax: 971-488-62830

**Asia Pacific**  
 Singapore  
 Tel: 65-6518-1800  
 Fax: 65-6518-1803

If the products featured will be used in a potentially dangerous and/or hazardous process, your John Crane representative should be consulted prior to their selection and use. In the interest of continuous development, John Crane Companies reserve the right to alter designs and specifications without prior notice. It is dangerous to smoke while handling products made from PTFE. Old and new PTFE products must not be incinerated. ISO 9001 and ISO 14001 Certified, details available on request.