

HIGH-TEMPERATURE CORROSION RESISTANT

Installation, Operation & Maintenance Instructions

Foreword

These instructions are provided to familiarize the user with the seal and its designated use. These instructions must be read and applied whenever work is done on the seal, and must be kept available for future reference.

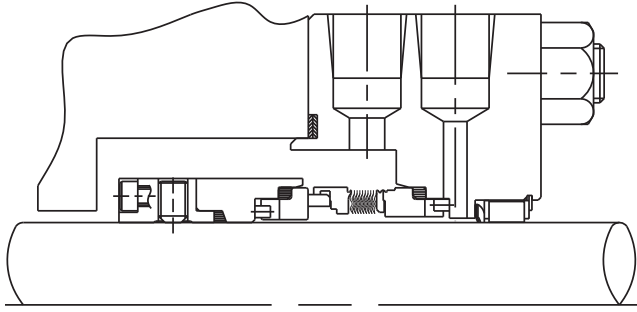

ATTENTION These instructions are for the installation and operation of a seal as used in rotating equipment and will help to avoid danger and increase reliability. The information required may change with other types of equipment or installation arrangements. These instructions must be read in conjunction with the instruction manuals for both the pump and any ancillary equipment.

If the seal is to be used for an application other than that originally intended or outside the recommended performance limits, John Crane must be contacted before its installation and use.

Any warranty may be affected by improper handling, installation or use of this seal. Contact John Crane for information as to exclusive product warranty and limitations of liability.

If questions or problems arise, contact your local John Crane representative or the original equipment manufacturer, as appropriate.

ATTENTION John Crane mechanical seals are precision products and must be handled appropriately. Take particular care to avoid damage to lapped sealing faces and to flexible sealing rings. Do not excessively compress the seal before or during installation.

ATTENTION Do not lap the seal primary ring face.

Safety Instructions

- The following designations are used in the installation instructions to highlight instructions of particular importance.

NOTE: Refers to special information on how to install or operate the seal most efficiently.

ATTENTION Refers to special information or instructions directed toward the prevention of damage to the seal or its surroundings.



Refers to mandatory instructions designed to prevent personal injury or extensive damage to the seal or its surroundings.

- Installation, removal, and maintenance of the seal must be carried out only by qualified personnel who have read and understood these installation instructions.
- The seal is designed exclusively for sealing rotating shafts. The manufacturer cannot be held liable for use of the seal for purposes other than this.
- The seal must only be used in technically perfect condition, and must be operated within the recommended performance limits in accordance with its designated use set out in these installation instructions.

- If the pumped fluid is hazardous or toxic, appropriate precautions must be taken to ensure that any seal leakage is adequately contained. Further information on sealing hazardous or toxic fluids should be obtained from John Crane prior to seal installation.
- Fluorocarbon components should never be burned or incinerated as the fumes and residues are highly toxic. If fluorocarbons are accidentally heated above 400°C/750°F, they can decompose. Protective gloves should be worn as hydrofluoric acid may be present.
- PTFE components should never be burned or incinerated as the fumes are highly toxic.

Before Starting The Equipment

- Check the pump at the coupling for proper alignment of the driver or motor.
- Ensure that the gland plate nuts/bolts are securely tightened according to the pump manual instructions, and that all screws are securely fastened.
- Complete the assembly of the pump, and turn the shaft (by hand if possible) to ensure free rotation.
- Consult all available equipment operating instructions to check for correctness of all piping and connections, particularly regarding seal recirculation/flush, heating or cooling requirements and services external to the seal.

ATTENTION This mechanical seal is designed to operate in a liquid so the heat energy it creates is adequately removed. Therefore, the following check should be carried out not only after seal installation, but also after any period of equipment inactivity.

- Check that the seal chamber fluid lines are open and free of any obstruction, and ensure that the seal chamber is properly vented and filled with liquid - refer to the pump instruction manual.

ATTENTION Dry-running - often indicated by a squealing noise from the seal area - will cause overheating and scoring or other damage to the sealing surfaces, resulting in excessive leakage or a much shortened seal life.



Before start-up, ensure that all personnel and assembly equipment have been moved to a safe distance, so there is no contact with rotating parts on the pump, seal, coupling or motor.

WARNING: Seal installation should be handled only by qualified personnel. If questions arise, contact the local John Crane representative. Improper use and/or installation of this product could result in injury to the person and/or harmful emissions to the environment, and may affect any warranty on the product. Please contact the company for information as to exclusive product warranty and limitations of liability.

General Instructions

1. Study the engineering layout drawing to confirm the proper seal arrangement for the pump being used. The Type 604HTC seal is designed for versatility and can be assembled in various ways. The following instructions describe the standard configurations.
2. To assure satisfactory operation, handle seal with care. Take particular caution to see that the lapped sealing faces are not scratched or damaged.

Part Name		
1 Mating Ring	6 Set Screws	11 Packing
2 Stationary Seal Assembly	7 Cap Screws	12 Retaining Screws
3 Packing	8 Gland Plate Assembly	13 Compression Ring
4 Mating Ring Adapter Assembly	9 Bushing	
5 Packing	10 Retaining Ring	

Typical Type 604HTC Seal Arrangement

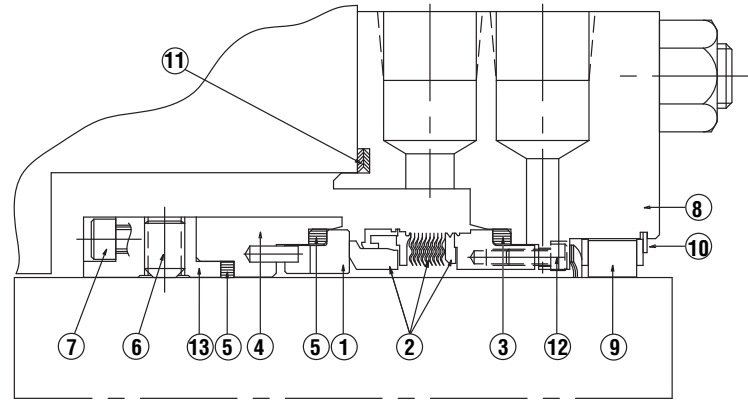

Preparing The Equipment

1. Check seal chamber dimensions and finishes.

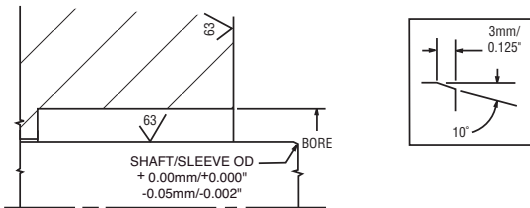

2. Measure axial end play (0.13mm/0.005" FIM max.).

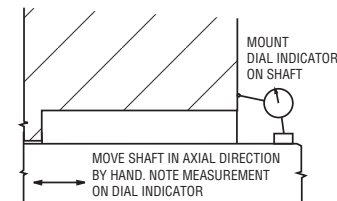

3. Determine squareness of seal chamber face to shaft (0.001mm per mm/0.001" per inch of shaft diameter FIM max.), and shaft concentricity to the seal chamber.

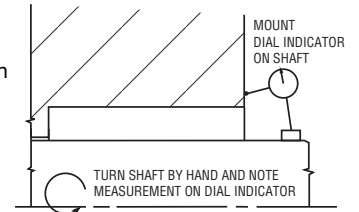

4. Measure shaft runout (0.001mm per mm/0.001" per inch of shaft diameter FIM max.).

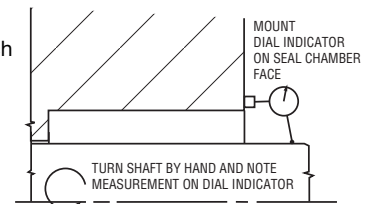

NOTE: If measured dimensions exceed those values given, correct the equipment to meet specifications prior to seal installation.

Component Seals

Setting the Seal

1. With the seal chamber and shaft/sleeve in their correct operating positions, use a straight edge to scribe the position of the seal chamber face onto the shaft/sleeve at A. Use machinist's blue to make the scribe easier to see.
2. Again remove the pump housing. From the installation drawing, determine the distance from the seal chamber face to the seal set length, and scribe line B onto the shaft sleeve at this distance.
3. Without disturbing the scribe line B, wipe the shaft/sleeve clean.

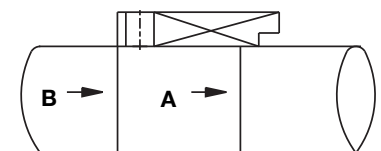
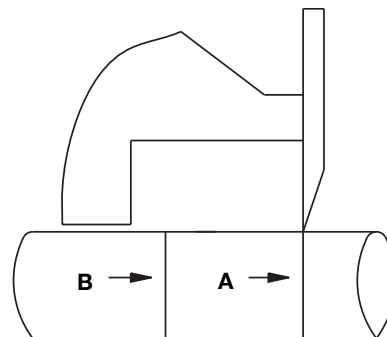

HIGH-TEMPERATURE CORROSION RESISTANT

Installation, Operation & Maintenance Instructions

Type 604HTC Dimensional Data (inch/mm) (without steam guide)

Sealot Dash No.	Shaft Size								Shaft Size							
	A	B	C	D	E	F	G	H	A	B	C	D	E	F	G	H
	inch								mm							
28	1.625	2.562	2.060	1.222	3.282	0.625	2.190	1.940	41.28	65.07	52.32	31.04	83.36	15.88	55.63	49.28
30	1.750	2.687	2.060	1.254	3.314	0.625	2.315	2.065	44.45	68.25	52.32	31.85	84.18	15.88	58.80	52.45
32	1.875	2.812	2.062	1.254	3.316	0.629	2.441	2.191	47.63	71.42	52.37	31.85	84.23	15.98	62.00	55.65
34	2.000	2.937	2.060	1.285	3.345	0.623	2.565	2.315	50.80	74.60	52.32	32.64	84.96	15.82	65.15	58.80
36	2.125	3.187	2.182	1.316	3.498	0.620	2.691	2.441	53.98	80.95	55.42	33.43	88.85	15.75	68.35	62.00
38	2.250	3.312	2.218	1.348	3.566	0.657	2.816	2.566	57.15	84.12	56.34	34.24	90.58	16.69	71.53	65.18
40	2.375	3.437	2.186	1.379	3.565	0.625	3.036	2.736	60.33	87.30	55.52	35.03	90.55	15.88	77.11	69.49
42	2.500	3.562	2.184	1.410	3.594	0.625	3.161	2.861	63.50	90.47	55.47	35.81	91.29	15.88	80.29	72.67
44	2.625	3.687	2.250	1.443	3.693	0.625	3.287	2.987	66.68	93.65	57.15	36.65	93.80	15.88	83.49	75.87
46	2.750	3.937	2.250	1.608	3.858	0.625	3.442	3.142	69.85	100.00	57.15	40.84	97.99	15.88	87.43	79.81
48	2.875	4.062	2.281	1.608	3.889	0.656	3.567	3.267	73.03	103.17	57.94	40.84	98.78	16.66	90.60	82.98
50	3.000	4.187	2.250	1.608	3.858	0.625	3.712	3.382	76.20	106.35	57.15	40.84	97.99	15.88	94.28	85.90
52	3.125	4.312	2.250	1.608	3.858	0.625	3.837	3.507	79.38	109.52	57.15	40.84	97.99	15.88	97.46	89.08
54	3.250	4.437	2.219	1.608	3.827	0.594	3.962	3.632	82.55	112.70	56.36	40.84	97.21	15.09	100.63	92.25
56	3.375	4.562	2.282	1.608	3.890	0.657	4.087	3.757	85.73	115.87	57.96	40.84	98.81	16.69	103.81	95.43
58	3.500	4.687	2.373	1.650	4.023	0.656	4.212	3.882	88.90	119.05	60.27	41.91	102.18	16.66	106.98	98.60
60	3.625	4.812	2.375	1.650	4.025	0.656	4.337	4.007	92.08	122.22	60.33	41.91	102.24	16.66	110.16	101.78
62	3.750	4.937	2.375	1.650	4.025	0.656	4.462	4.132	95.25	125.40	60.33	41.91	102.24	16.66	113.33	104.95
64	3.875	5.062	2.375	1.650	4.025	0.656	4.587	4.257	98.43	128.57	60.33	41.91	102.24	16.66	116.51	108.13
68	4.125	5.312	2.188	1.650	3.838	0.457	4.852	4.492	104.78	134.92	55.58	41.91	97.49	11.61	123.24	114.10
72	4.375	5.562	2.375	1.650	4.025	0.656	5.102	4.742	111.13	141.27	60.33	41.91	102.24	16.66	129.59	120.45
76	4.625	5.812	2.360	1.650	4.010	0.641	5.352	4.992	117.48	147.62	59.94	41.91	101.85	16.28	135.94	126.80
80	4.875	6.187	2.375	1.650	4.025	0.656	5.609	5.249	123.83	157.15	60.33	41.91	102.24	16.66	142.47	133.32
84	5.125	6.437	2.375	1.806	4.181	0.656	5.878	5.478	130.18	163.50	60.33	45.87	106.20	16.66	149.30	139.14
88	5.375	6.687	2.375	1.806	4.181	0.656	6.125	5.725	136.53	169.85	60.33	45.87	106.20	16.66	155.58	145.42
92	5.625	6.937	2.375	1.806	4.181	0.656	6.369	5.969	142.88	176.20	60.33	45.87	106.20	16.66	161.77	151.61
104	6.375	7.687	2.375	1.806	4.181	0.656	7.122	6.722	161.93	195.25	60.33	45.87	106.20	16.66	180.90	170.74
112	6.875	8.187	2.375	1.806	4.181	0.656	7.619	7.219	174.63	207.95	60.33	45.87	106.20	16.66	193.52	183.36

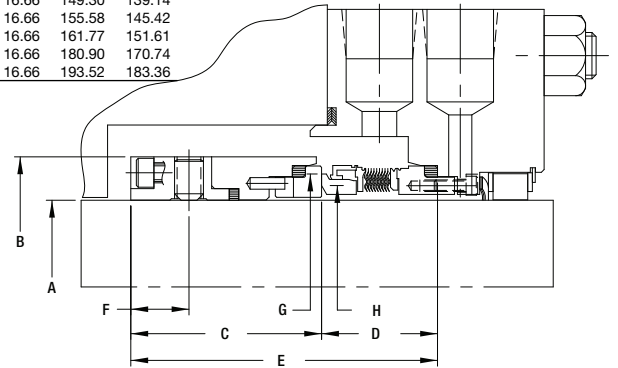
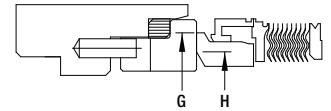

Type 604HTC Dimensional Data (inch/mm) (with steam guide)

Sealot Dash No.	Shaft Size								Shaft Size							
	A	B	C	D	E	F	G	H	A	B	C	D	E	F	G	H
	inch								mm							
28	1.500	2.562	2.057	1.222	3.279	0.617	2.190	1.940	38.10	65.07	52.25	31.04	83.29	15.67	55.63	49.28
30	1.625	2.687	2.065	1.253	3.318	0.625	2.315	2.065	41.28	68.25	52.45	31.83	84.28	15.88	58.80	52.45
32	1.750	2.812	2.065	1.253	3.318	0.625	2.441	2.191	44.45	71.42	52.45	31.83	84.28	15.88	62.00	55.65
34	1.875	2.937	1.970	1.285	3.255	0.563	2.565	2.315	47.63	74.60	50.04	32.64	82.68	14.30	65.15	58.80
36	2.000	3.187	2.189	1.317	3.506	0.625	2.691	2.441	50.80	80.95	55.60	33.45	89.05	15.88	68.35	62.00
38	2.125	3.312	2.230	1.348	3.578	0.645	2.816	2.566	53.98	84.12	56.64	34.24	90.88	16.38	71.53	65.18
40	2.250	3.437	2.189	1.379	3.568	0.625	3.036	2.736	57.15	87.30	55.60	35.03	90.63	15.88	77.11	69.49
42	2.375	3.562	2.189	1.411	3.600	0.625	3.161	2.861	60.33	90.47	55.60	35.84	91.44	15.88	80.29	72.67
44	2.500	3.687	2.252	1.443	3.695	0.625	3.287	2.987	63.50	93.65	57.20	36.65	93.85	15.88	83.49	75.87
46	2.625	3.937	2.345	1.608	3.953	0.656	3.442	3.142	66.68	100.00	59.56	40.84	100.41	16.66	87.43	79.81
48	2.750	4.063	2.282	1.608	3.890	0.656	3.567	3.267	69.85	103.20	57.96	40.84	98.81	16.66	90.60	82.98
50	2.875	4.187	2.283	1.608	3.891	0.656	3.712	3.382	73.03	106.35	57.99	40.84	98.83	16.66	94.28	85.90
52	3.000	4.312	2.283	1.608	3.891	0.656	3.837	3.507	76.20	109.52	57.99	40.84	98.83	16.66	97.46	89.08
54	3.125	4.437	2.282	1.608	3.890	0.656	3.962	3.632	79.38	112.70	57.96	40.84	98.81	16.66	100.63	92.25
56	3.250	4.563	2.283	1.608	3.891	0.656	4.087	3.757	82.55	115.90	57.99	40.84	98.83	16.66	103.81	95.43
58	3.375	4.687	2.377	1.650	4.027	0.656	4.212	3.882	85.73	119.05	60.38	41.91	102.29	16.66	106.98	98.60
60	3.500	4.812	2.377	1.650	4.027	0.656	4.337	4.007	88.90	122.22	60.38	41.91	102.29	16.66	110.16	101.78
62	3.625	4.937	2.377	1.650	4.027	0.656	4.462	4.132	92.08	125.40	60.38	41.91	102.29	16.66	113.33	104.95
64	3.750	5.062	2.377	1.650	4.027	0.656	4.587	4.257	95.25	128.57	60.38	41.91	102.29	16.66	116.51	108.13
68	4.000	5.312	2.377	1.650	4.027	0.656	4.852	4.492	101.60	134.92	60.38	41.91	102.29	16.66	123.24	114.10
72	4.250	5.563	2.377	1.650	4.027	0.656	5.102	4.742	107.95	141.30	60.38	41.91	102.29	16.66	129.59	120.45
76	4.500	5.812	2.377	1.650	4.027	0.656	5.352	4.992	114.30	147.62	60.38	41.91	102.29	16.66	135.94	126.80
80	4.750	6.188	2.377	1.650	4.027	0.656	5.609	5.249	120.65	157.18	60.38	41.91	102.29	16.66	142.47	133.32
84	5.000	6.437	2.377	1.806	4.183	0.656	5.878	5.478	127.00	163.50	60.38	45.87	106.25	16.66	149.30	139.14
88	5.250	6.687	2.377	1.806	4.183	0.656	6.125	5.725	133.35	169.85	60.38	45.87	106.25	16.66	155.58	145.42
92	5.500	6.937	2.377	1.806	4.183	0.656	6.369	5.969	139.70	176.20	60.38	45.87	106.25	16.66	161.77	151.61
104	6.250	7.687	2.377	1.806	4.183	0.656	7.122	6.722	158.75	195.25	60.38	45.87	106.25	16.66	180.90	170.74
112	6.750	8.187	2.377	1.806	4.183	0.656	7.619	7.219	171.45	207.95	60.38	45.87	106.25	16.66	193.52	183.36

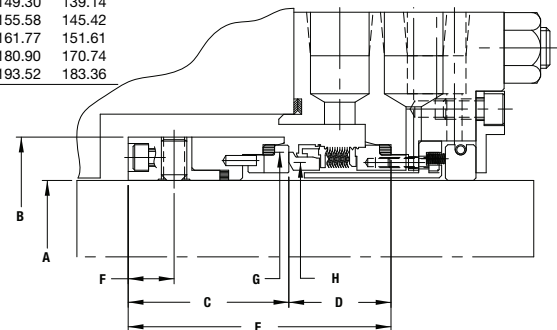

HIGH-TEMPERATURE CORROSION RESISTANT

Installation, Operation & Maintenance Instructions

Installing The Seal

1. Unwrap the mechanical seal components, taking care not to scratch or damage the seal faces. Place the stationary packing into the packing cavity of the gland plate. Carefully place the drive collar of the stationary seal assembly in position over the stationary packing, with any drive pins aligned with their corresponding slots in the stationary seal assembly. With the appropriate diameter mandrel, evenly press the drive collar of the stationary seal assembly into position. Take care not to damage the seal face or compress the bellows assembly during the installation process. Install retaining screws, if required, in seal assembly. Carefully slide the complete gland assembly, including the gland gasket, onto the shaft as far away as possible from the seal chamber.

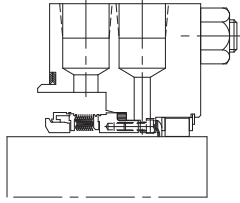

2. Slide the rotating assembly onto the shaft/sleeve, being careful not to damage the packing. Move the compression ring down the shaft and position it behind the flexible graphite packing and mating ring adaptor. Caution should be taken, however, to avoid twisting the flexible graphite packing. Referring to the assembly drawing, align the back of the mating ring adaptor assembly with scribe line B, and tighten the set screws evenly. (Once tightened, set screws should not be re-used. If you must loosen the set screws for any reason, replace them before repeating step 2.)

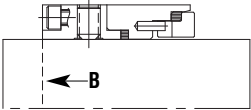

3. Being careful not to damage the seal, reassemble the seal chamber housing and install the impeller.

Ensure the gland gasket is in place. Slide the gland assembly into position against the face of the seal chamber. Assemble the gland bolts finger tight. Continue tightening alternately until secure. Do not distort the gland by overtightening. Verify the gland is concentric with the shaft sleeve to prevent possible damage due to rubbing.

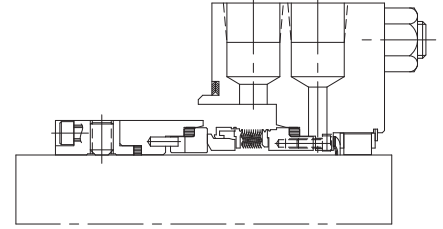

4. Complete reassembly of the pump, frequently turning the shaft by hand to check for free rotation.

If the shaft will not turn, seal has been improperly set.

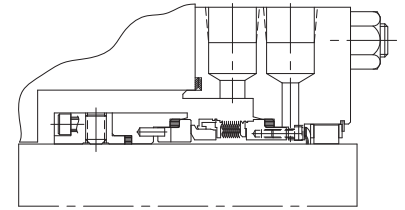

ATTENTION Refer to assembly drawing and/or pump manual for piping connections and coupling alignment. Proceed as indicated.

Cartridge Seals

Installing the Seal in an Overhung Pump

1. Disassemble the seal chamber housing. Take both complete cartridges from their packages. Do not disassemble or alter the unit.
2. Slide the packing follower and flexible graphite packing as far as possible onto the shaft/sleeve, toward the bearings. Slide the complete cartridge assembly as far as possible onto the shaft/sleeve. Reassemble the seal chamber housing and the impeller.
3. With the gland gasket in place, slide the complete assembly into position against the face of the seal chamber. Assemble the gland bolts finger tight. Continue tightening alternately until secure. Do not distort the gland by overtightening.
4. Leave the eccentric washers or shipping clips in place to maintain the setting position of the cartridge seal.

5. If the assembly drawing calls for holes or countersinks to be drilled under the cartridge sleeve set screws, remove the set screws and mark their location. Unbolt the cartridge gland and remove the impeller, the seal chamber housing and the cartridge assembly. Drill the shaft/sleeve in the positions marked. Repeat steps 1-4.
6. Tighten and compress flexible graphite packings.
7. Tighten the cartridge sleeve set screws evenly. (If the shaft/sleeve has been drilled, ensure that the set screws align with the appropriate drilled holes.)
8. Remove the shipping clips or rotate the eccentric washers 180° to clear the slot in the cartridge sleeve.
9. Complete reassembly of the pump, frequently turning the shaft by hand to check for free rotation. If the shaft will not turn, the seal has been improperly set.

ATTENTION Refer to assembly drawing and/or pump manual for piping connections and coupling alignment. Proceed as indicated.

Installing The Seal Between Bearings

1. Disassemble the bearings and bearing housings. Take both complete cartridges from their packages. Do not disassemble or alter the units.
2. Slide the complete cartridge assemblies onto the shaft/sleeves, being careful not to damage the packings inside the cartridge sleeves. Slide the packing follower and flexible graphite packing as far as possible onto the shaft/sleeve, towards the bearings. Reassemble the bearing housings and bearings, and complete all required axial adjustments to the pump rotating assembly.
3. With the gland gasket in place, slide the complete assembly into position against the face of the seal chamber. Assemble the gland bolts finger tight. Continue tightening alternately until secure. Do not distort the gland by overtightening.
4. Leave the eccentric washers or shipping clips in place to maintain the setting position of the cartridge seal.

5. If the assembly drawing calls for holes or countersinks to be drilled under the cartridge sleeve set screws, remove the set screws and mark their location. Unbolt the cartridge gland, remove the bearings, bearing housings, and cartridge assemblies. Drill the shaft/sleeves in the positions marked. Repeat steps 1-4.
6. Tighten and compress flexible graphite packings.
7. Tighten the cartridge sleeve set screws evenly. (If the shaft/sleeve has been drilled, ensure that the set screws align with the appropriate drilled holes.)
8. Remove the shipping clips or rotate the eccentric washers 180° to clear the slot in the cartridge sleeve.
9. Complete reassembly of the pump, frequently turning the shaft by hand to check for free rotation. If the shaft will not turn, the seal has been improperly set.

ATTENTION Refer to assembly drawing and/or pump manual for piping connections and coupling alignment. Proceed as indicated.

HIGH-TEMPERATURE CORROSION RESISTANT

Installation, Operation & Maintenance Instructions

Decommissioning The Equipment

1. Ensure that the equipment is electrically isolated.



If the equipment has been used on toxic or hazardous fluids, ensure that the equipment is correctly decontaminated and made safe prior to commencing work. Remember, fluid is often trapped during draining and may exist outside the seal. The pump instruction manual should be consulted to check for any special precautions.

2. Ensure that the equipment is isolated by the appropriate valves. Check that the fluid is drained and pressure is fully released.

Maintenance

No maintenance of a seal is possible while installed. Therefore, it is recommended that a spare seal unit and mating ring be held in stock to allow immediate replacement of a removed seal.

It is recommended that used seals be returned to a John Crane Seal Rebuilding Center, as rebuilding to as-new specifications must be carried out by qualified personnel.



It is the responsibility of the equipment user to ensure that any parts being sent to a third party have appropriate safe handling instructions externally attached to the package.

Quality Assurance

This seal has been assembled in accordance with John Crane Quality Assurance Standards, and with proper maintenance and use will give safe and reliable operation to the maximum recommended performance as shown in any relevant approved John Crane publication.

Materials of Construction - Standard

Bellows Assembly:	Heat Treated Alloy 718
Adaptive Hardware:	300 Series Stainless Steel
Faces:	Graphite-loaded Silicon Carbide (Sealide-C™) Silicon Carbide Nickel Bonded Tungsten Carbide
Static Seals	Flexible Graphite

Sealide-C is a trademark of John Crane Inc.

Operating (non-concurrent) Limits

Pressure:	Vacuum to 20 bar/300 psi
Temperature:	-75°C to 425°C/-100°F to 800°F (with flexible graphite static packing)
Speed:	To 50 mps/10,000 sfpm

Ordering Information

1. Cartridge seal size = solid shaft or sleeve OD.
2. Select single 604HTC arrangement.
3. Determine whether seal chamber is standard or API 610.
4. For other material combinations or size considerations, consult the local John Crane representative.

TYPE 604HTC

HIGH-TEMPERATURE CORROSION RESISTANT

TYPE 604HTC

HIGH-TEMPERATURE CORROSION RESISTANT

Installation, Operation & Maintenance Instructions

HIGH-TEMPERATURE CORROSION RESISTANT

Installation, Operation & Maintenance Instructions



North America
 United States of America
 Tel: 1-847-967-2400
 Fax: 1-847-967-3915

Europe
 United Kingdom
 Tel: 44-1753-224000
 Fax: 44-1753-224224

Latin America
 Brazil
 Tel: 55-11-3371-2500
 Fax: 55-11-3371-2599

Middle East & Africa
 United Arab Emirates
 Tel: 971-481-27800
 Fax: 971-488-62830

Asia Pacific
 Singapore
 Tel: 65-6518-1800
 Fax: 65-6518-1803

If the products featured will be used in a potentially dangerous and/or hazardous process, your John Crane representative should be consulted prior to their selection and use. In the interest of continuous development, John Crane Companies reserve the right to alter designs and specifications without prior notice. It is dangerous to smoke while handling products made from PTFE. Old and new PTFE products must not be incinerated. ISO 9001 and ISO14001 Certified, details available on request.