

PRESS ON SEAL ADAPTER TO INSTALL

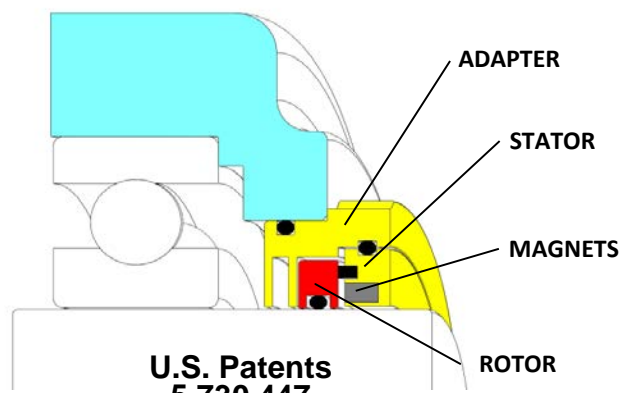

U.S. Patents
5,730,447
6,805,358

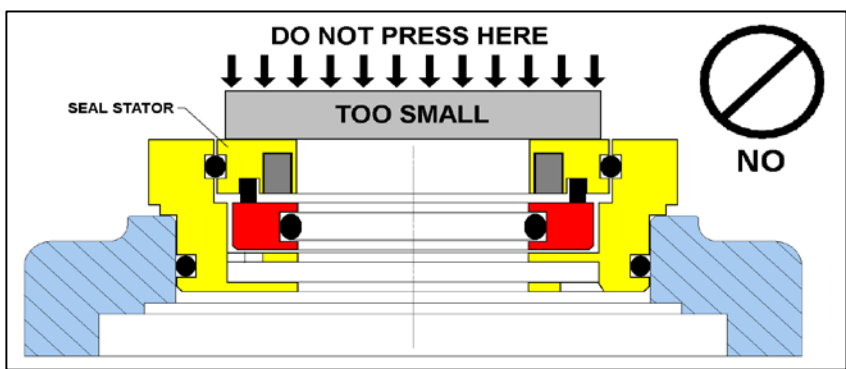
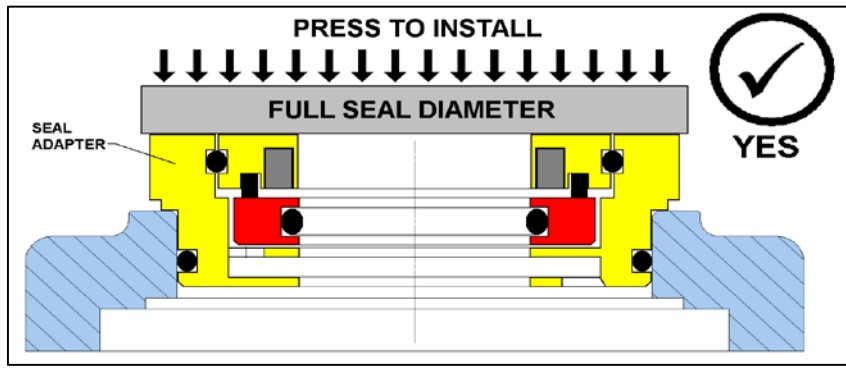

INSTALLATION GUIDE

MAGNUM CARTRIDGE OIL SEALS

Thank you for choosing Isomag oil seals for your bearing and environmental protection. Please use this installation guide as a reference to assure maximum seal life in your installation.

HOW TO READ THE BOX LABEL:

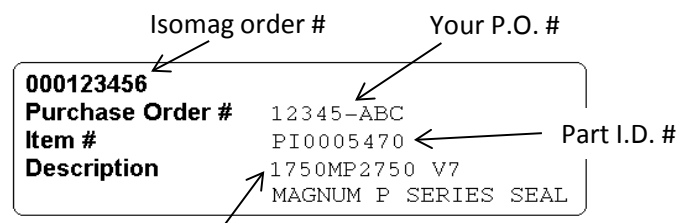

Assembly code & description

- | | |
|--------------------------------|--|
| How to read the assembly code: | 1750 = Seal fits 1.750" shaft dia. |
| | MP = Seal model |
| | 2750 = Seal fits 2.750" housing bore dia. |
| | V7 = Seal series |

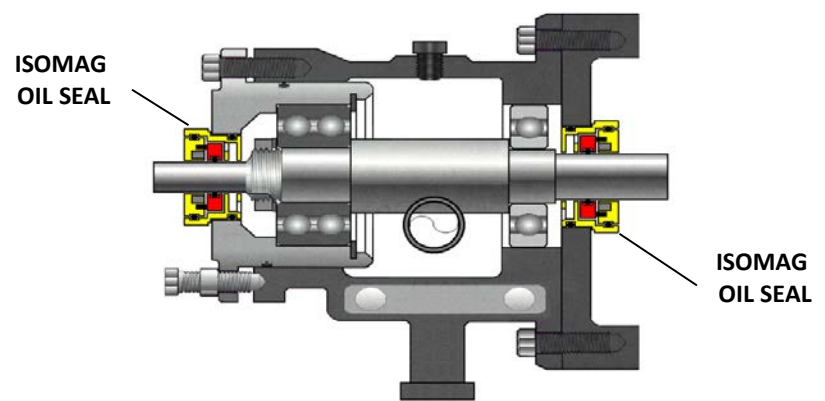

TYPICAL ANSI PUMP

ISOMAG
11871 Dunlay Lane
Baton Rouge, LA 70809

Phone: 225-752-0926
Fax: 225-756-3141
Website: isomag.com

STEP #1

CHECK HOST EQUIPMENT MECHANICAL CONDITION

1. Shaft diameter +/- .002" tolerance
2. Shaft run out .002" per inch of diameter @ 1800 rpm
3. Shaft surface finish 32 rms or better, smooth & defect free
4. Housing bore diameter +.002", -.000" tolerance
5. Housing bore roundness .002" tolerance
6. Housing bore concentric with shaft less than .020"
7. Housing face square to shaft .001" per inch of diameter
8. Housing bore surface condition smooth & defect free

STEP #2

PREPARE HOST EQUIPMENT

1. Clean, inspect & measure shaft and housing
2. Break or smooth all sharp edges
3. Remove all old oil, lubricants and contaminants

SHARP CORNERS CUT O-RINGS & MAKE LEAK PATHS

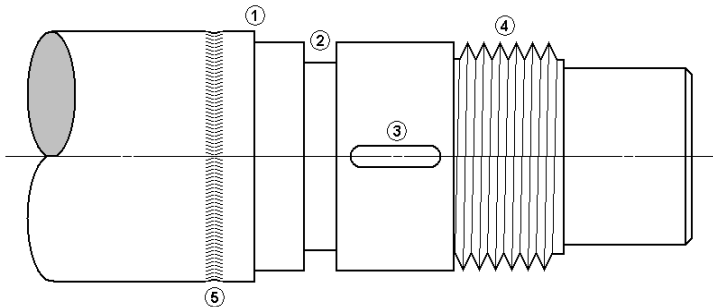

(1.) Sharp corners, (2.) grooves, (3.) keyways and (4.) threads may cut rotor o-ring during installation. (5.) Fret groove made by lip seal or labyrinth may cause seal to leak.

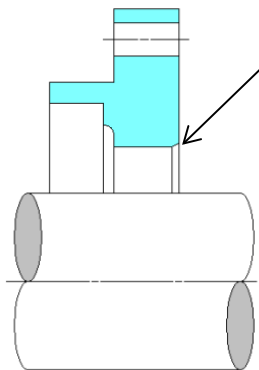

**BEVEL HOUSING BORE
.030" X 30° RECOMMENDED**

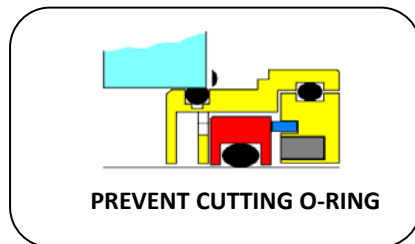

PREVENT CUTTING O-RING

STEP #3

ASSEMBLY LUBRICANT

1. **DO NOT LUBRICATE ROTOR O-RING**
2. **LUBRICATE HOST EQUIPMENT SEAL HOUSING BORE**
Use the **host equipment bearing lubricant only**
3. **DO NOT USE ANTI-SIEZE PRODUCTS NEAR SEAL**
Anti-seize contains metal particles that will damage seal

**SEAL ORIENTATION
SEALS INSTALLED ON HORIZONTAL SHAFT**

